

GigaDevice Semiconductor Inc.

GD30LD3137x

1.2A High-accuracy, Low Noise LDO

Datasheet

Table of Contents

Table of Contents	2
List of Figures	4
List of Tables	5
1 Features	6
2 Applications	6
3 General description	6
4 Device overview	7
4.1 Device information	7
4.2 Block diagram	7
4.3 Pinout and pin assignment	8
4.4 Pin definitions	8
5 Functional description	10
5.1 Output Voltage Setting	10
5.2 Recommended device selection	10
5.2.1 C_{IN} and C_{OUT} Selection.....	10
5.2.2 Feed-Forward Capacitor (C_{FF}).....	10
5.3 Low-Noise, High-RSRR Output	10
5.4 Power-Good Function	11
5.5 Soft-Start Function	12
5.6 Undervoltage Lockout (UVLO)	12
5.7 Power Dissipation (P_D)	14
6 Electrical characteristics	15
6.1 Absolute maximum ratings	15
6.2 Recommended Operating Conditions	15
6.3 Electrical sensitivity	16
6.4 Electrical Specifications	16
6.5 Typical Characteristics	19
7 Typical application circuit	27
8 Layout guideline	28
9 Package information	29



9.1	DFN8 package outline dimensions.....	29
9.2	Thermal characteristics	31
10	Ordering information.....	32
11	Revision history.....	33

List of Figures

Figure 4-1 Block diagram for GD30LD3137x	7
Figure 4-2 GD30LD3137x DFN8 pinouts.....	8
Figure 5-1 Typical PG Operation.....	11
Figure 5-2 Typical UVLO Operation	13
Figure 7-1 Typical GD30LD3137x application circuit with adjustable resistance	27
Figure 8-1 Typical GD30LD3137x layout guideline	28
Figure 9-1 DFN8 package outline.....	29
Figure 9-2 DFN8 recommended footprint	30

List of Tables

Table 4-1. Device information for GD30LD3137x	7
Table 4-2. GD30LD3137x DFN8 pin definitions.....	8
Table 5-1 Typical PG Operation Description	11
Table 5-2 Typical UVLO Operation Description	13
Table 6-1 Absolute maximum ratings	15
Table 6-2 Recommended Operating Conditions	15
Table 6-3 Electrostatic Discharge characteristics.....	16
Table 6-4 Electrical characteristics.....	16
Table 7-1 Adjusted V_{OUT} by external feedback resistor.....	27
Table 9-1. DFN8 dimensions	29
Table 9-2. Package thermal characteristics ⁽¹⁾	31
Table 10-1 Part ordering code for GD30LD3137x devices.....	32
Table 11-1 Revision history	33

1 Features

- Input Voltage Range
 - With BIAS: 1.1 V to 6.5 V
 - Without BIAS: 1.4 V to 6.5 V
- Output Voltage Range
 - 0.8 V to 5.5 V, Set by a Resistor Divider
- Accurate Output Voltage Accuracy: 1%, Over Line, Load and Temperature
- Ultra Low Dropout Voltage: 70 mV at 1.2A
- Ultra High PSRR: 40 dB at 500 KHz
- Excellent Noise Immunity
 - 4.4 μ VRMS at 0.8 V Output
 - 7.7 μ VRMS at 5 V Output
- Enable Function
- Programmable Soft-Start
- Power-Good Indicator Function

2 Applications

- Wireless Infrastructure: 5G AAU, 4G RRU....
- Telecom/Networking Cards
- Industrial Application

3 General description

The GD30LD3137x is a high-current, low-noise, high accuracy, low-dropout linear regulator (LDO) capable of sourcing 1.2A with extreme low dropout (max 75mV). The device output voltage is adjustable from 0.8 V to 5.5V using the external resistor divider. The device supports input supply voltage as low to 1.1 V with BIAS and as low to 1.4 V without BIAS.

The low noise, high PSRR and high output current capability makes the GD30LD3137x ideal to power noise-sensitive devices such as analog-to-digital converters (ADCs), digital-to-analog converters (DACs), and RF components. With very high accuracy, remote sensing, and soft-start capabilities to reduce inrush current, the GD30LD3137x is ideal for powering digital loads such as FPGAs, DSPs, and ASICs.

The external enable control and power good indicator function makes the control sequence easier. The output noise immunity is enhanced by adding external bypass capacitor on NR/SS pin. The device is fully specified over the temperature range of $T_J = -40^{\circ}\text{C}$ to 125°C and is offered in a DFN-8L 3x3 package.

4 Device overview

4.1 Device information

Table 4-1. Device information for GD30LD3137x

Part Number	Package	Function	Description
GD30LD3137x	DFN8(3X3)	With EN enable pin	1.2A High accuracy and Low noise

4.2 Block diagram

Figure 4-1 Block diagram for GD30LD3137x

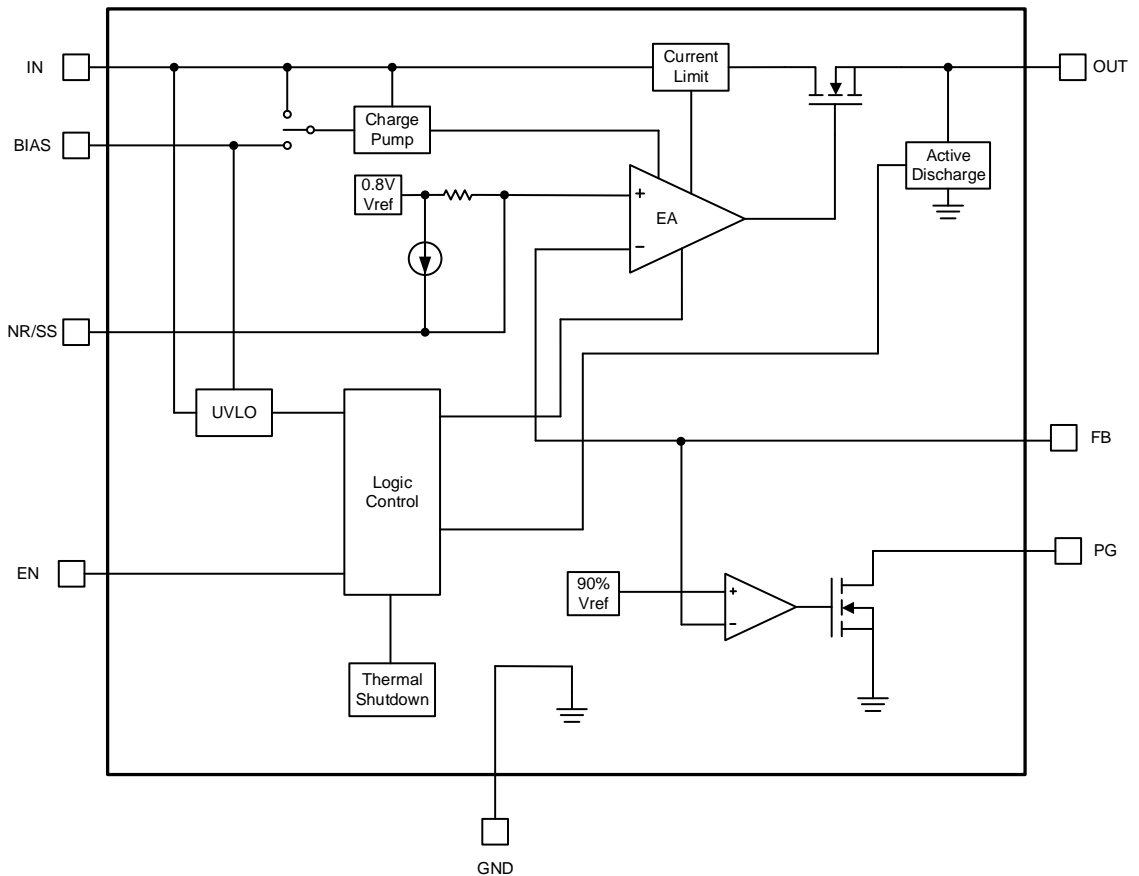

4.3 Pinout and pin assignment

Figure 4-2 GD30LD3137x DFN8 pinouts

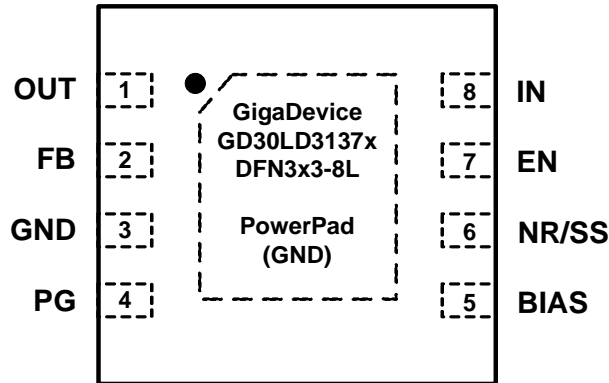

4.4 Pin definitions

Table 4-2. GD30LD3137x DFN8 pin definitions

Pin Name	Pins	Pin Type	Functions description
OUT	1	O	LDO output pins. A 4.7 μ F or greater capacitance is required for stability. Place the output capacitor as close to the device as possible. Minimize the impedance between V _{OUT} pin to load.
FB	2	I	Feedback voltage input. This pin is used to set the desired output voltage via an external resistive divider. The feedback reference voltage is 0.8V typically.
GND	3	G	Ground. The exposed pad must be soldered to a large PCB and connected to GND for maximum power dissipation.
PG	4	O	Power good indicator output. An open-drain output and active high when the output voltage reaches 90% of the target. The pin is pulled to ground when the output voltage is lower than its specified threshold, EN shutdown, OCP and OTP.
BIAS	5	P	BIAS supply voltage. This pin enables the use of low-input voltage, low-output voltage conditions (that is, V _{IN} = 1.2 V, V _{OUT} = 1 V) to reduce power dissipation across the die. The use of a BIAS voltage improves dc and ac performance for V _{IN} \leq 2.2 V. A 1 μ F capacitor or larger must be connected between this pin and ground. If not

Pin Name	Pins	Pin Type	Functions description
			used, this pin must be left floating or tied to ground.
NR/SS	6	I	Noise-reduction and soft-start pin. Decouple this pin to GND with an external capacitor $C_{NR/SS}$ can not only reduce output noise to very low levels but also slow down the rising of V_{OUT} , providing a soft-start behavior. For low noise applications, a 10nF to 1 μ F $C_{NR/SS}$ is suggested.
EN	7	I	Enable control input. Connecting this pin to logic high enables the regulator, and driving this pin low puts it into shutdown mode. The device can have V_{IN} and V_{EN} sequenced in any order without causing damage to the device. However, for the soft-start function to work as intended, certain sequencing rules must be applied. Enabling the device after V_{IN} is present is preferred.
IN	8	P	Supply input. A 10 μ F or greater capacitance is required. The capacitor should be placed as close as possible to this pin for better noise rejection.
Thermal PAD	9	G	Thermal pad for better heat dissipation, always connect this pin to GND

Notes:

1. Type: I = input, O = output, I/O = input or output, P = power, G = Ground.

5 Functional description

5.1 Output Voltage Setting

By using external resistors, the output voltage of GD30LD3137x is determined by the values of R1 and R2 as shown in [Table 7-1](#) Adjusted VOUT by external feedback resistor. The values of R1 and R2 can be calculated for any voltage value using the following formula:

$$V_{OUT} = V_{FB} \times \left(1 + \frac{R_1}{R_2} \right)$$

5.2 Recommended device selection

5.2.1 C_{IN} and C_{OUT} Selection

The GD30LD3137x is designed to support low-series resistance (ESR) ceramic capacitors. It is recommended to use ceramic capacitors with X7R, X5R, and C0G-rated ceramic capacitors to get good capacitive stability across different temperatures.

However, the capacitance of ceramic capacitors varies with operating voltage and temperature, and the design engineer must be aware of these characteristics. Ceramic capacitors are usually recommended to be derated by 50%. A 4.7μF or greater output ceramic capacitor is suggested to ensure stability. Input capacitance is selected to minimize transient input drop during load current steps. For general applications, an input capacitor of at least 10μF is highly recommended for minimal input impedance. If the trace inductance between the GD30LD3137x input pin and power supply is high, a fast load transient can cause V_{IN} voltage level ringing above the absolute maximum voltage rating which damages the device. Adding more input capacitors is available to restrict the ringing and keep it below the device absolute maximum ratings.

5.2.2 Feed-Forward Capacitor (C_{FF})

Although a feed-forward capacitor (C_{FF}) from the FB pin to the OUT pin is not required to achieve stability, a 10nF external feed-forward capacitor optimizes the transient, noise, and PSRR performance. A higher capacitance C_{FF} can be used; however, the start-up time is longer and the power-good signal can incorrectly indicate that the output voltage is settled.

5.3 Low-Noise, High-RSRR Output

The GD30LD3137x includes a low-noise reference and error amplifier ensuring minimal noise during operation. The NR/SS capacitor (C_{NR/SS}) and feed-forward capacitor (C_{FF}) are

the easiest way to reduce device noise. $C_{NR/SS}$ filters the noise from the reference and CFF filters the noise from the error amplifier. The noise contribution from the charge pump is minimal. The overall noise of the system at low output voltages can be reduced by using a bias rail because this rail provides more headroom for internal circuitry.

The high power-supply rejection ratio (PSRR) of the GD30LD3137x ensures minimal coupling of input supply noise to the output. The PSRR performance is primarily results from a high-bandwidth, high-gain error amplifier and an innovative circuit to boost the PSRR between 200 kHz and 1 MHz.

5.4 Power-Good Function

The PG circuit monitors the voltage at the feedback pin to indicate the status of the output voltage. The PG circuit asserts whenever V_{FB} , V_{IN} , or EN are below their thresholds. The PG operation versus the output voltage is shown in Figure 5-1, which is described by Figure 5-1.

Figure 5-1 Typical PG Operation

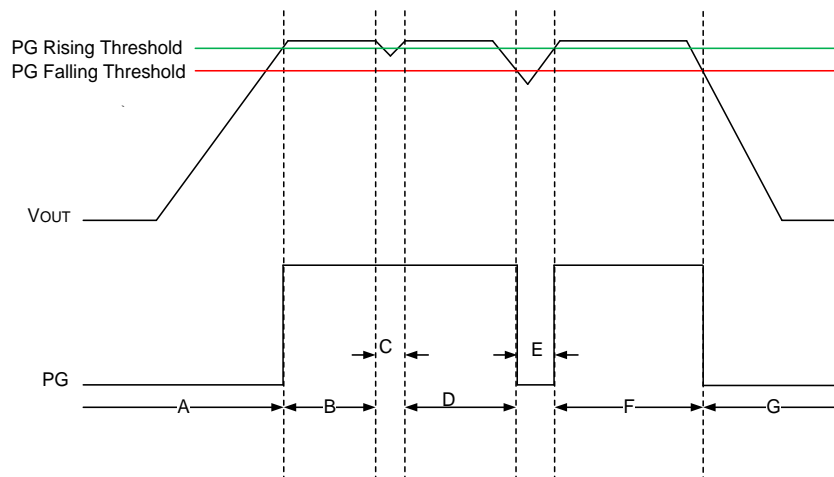

Table 5-1 Typical PG Operation Description

Region	EVENT	PG STATUS	FB VOLTAGE
A	Turn on	0	$V_{FB} < V_{IT(PG)} + V_{HYS(PG)}$
B	Regulation	Hi-Z	$V_{FB} \geq V_{IT(PG)}$
C	Output voltage dip	Hi-Z	
D	Regulation	Hi-Z	
E	Output voltage dip	0	$V_{FB} < V_{IT(PG)}$
F	Regulation	Hi-Z	$V_{FB} \geq V_{IT(PG)}$
G	Turnoff	0	$V_{FB} < V_{IT(PG)}$

The PG pin is open-drain, and connecting a pull-up resistor to an external supply enables others devices to receive Power Good as a logic signal that can be used for sequencing. Make sure that the external pull-up supply voltage results in a valid logic signal for the receiving device or devices.

To ensure proper operation of the PG circuit, the pull-up resistor value must be from 10 kΩ and 100 kΩ. The lower limit of 10 kΩ results from the maximum pulldown strength of the PG transistor, and the upper limit of 100 kΩ results from the maximum leakage current at the PG node. If the pull-up resistor is outside of this range, then the PG signal may not read a valid digital logic level.

5.5 Soft-Start Function

The GD30LD3137x is designed for a programmable, monotonic soft-start time during the output rising, which can be achieved via an external capacitor ($C_{NR/SS}$) on NR/SS pin. Using an external $C_{NR/SS}$ is recommended for general application, it is not only for the in-rush current minimization but also helps reduce the noise component from the internal reference. During the monotonic start-up procedure, the error amplifier of the GD30LD3137x tracks the voltage ramp of the external soft-start capacitor ($C_{NR/SS}$) until the voltage approaches the internal reference 0.8V.

The soft-start ramp time can be calculated with equation, which depends on the soft-start charging current ($I_{NR/SS}$), the soft-start capacitance ($C_{NR/SS}$), and the internal reference 0.8V (V_{FB}).

$$t_{SS} = (V_{NR/SS} \times C_{NR/SS}) / I_{NR/SS}$$

For noise-reduction, $C_{NR/SS}$ in conjunction with an internal noise-reduction resistor forms a low-pass filter (LPF) and filters out the noise from the internal bandgap reference before being amplified via the error amplifier, thus reducing the total device noise floor.

5.6 Undervoltage Lockout (UVLO)

The UVLO circuits ensure that the device stays disabled before its input or bias supplies reach the minimum operational voltage range, and ensures that the device properly shuts down when either the input or bias supply collapses. Figure 5-2 and Table 5-2 explain one of the UVLO circuits being triggered to various input voltage events, assuming $V_{EN} \geq V_{IH(EN)}$.

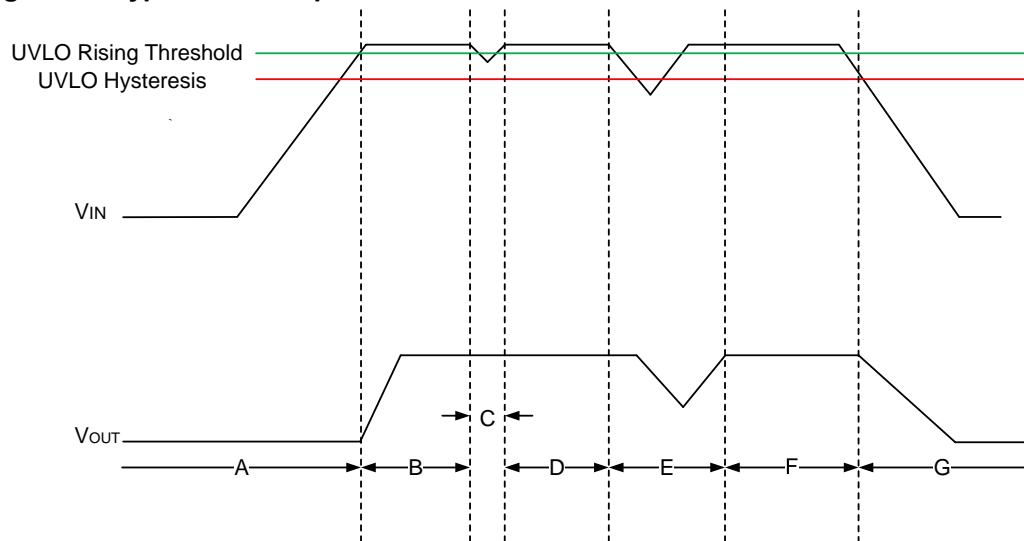
Figure 5-2 Typical UVLO Operation

Table 5-2 Typical UVLO Operation Description

Region	EVENT	VOUT STATUS	COMMENT
A	Turn on, $V_{IN} \geq V_{UVLO_1,2(IN)}$ and $V_{BIAS} \geq V_{UVLO(BIAS)}$	Off	Startup
B	Regulation	On	Regulates to target V_{OUT}
C	Brown out, $V_{IN} \geq V_{UVLO_1,2(IN)} - V_{HYS_1,2(IN)}$ or $V_{UVLO(BIAS)} - V_{HYS(BIAS)}$	On	The output can fall out of regulation but the device is still enabled
D	Regulation	On	Regulates to target V_{OUT}
E	Brownout $V_{IN} < V_{UVLO_1,2(IN)} - V_{HYS_1,2(IN)}$ or $V_{BIAS} < V_{UVLO(BIAS)} - V_{HYS(BIAS)}$	Off	The device is disabled and the output falls because of the load and active discharge circuit. The device is reenabled when the UVLO fault is removed when either the IN or BIAS UVLO rising threshold is reached by the input or bias voltage and a normal start-up then follows.
F	Regulation	On	Regulates to target V_{OUT}
G	Turnoff, $V_{IN} < V_{UVLO_1,2(IN)} - V_{HYS_1,2(IN)}$ or $V_{BIAS} < V_{UVLO(BIAS)} - V_{HYS(BIAS)}$	Off	The output falls because of the load and active discharge circuit.

Similar to many other LDOs with this feature, the UVLO circuits take a few microseconds to fully assert. During this time, a downward line transient below approximately 0.8 V causes the UVLO to assert for a short time; however, the UVLO circuits do not have enough stored

energy to fully discharge the internal circuits inside of the device. When the UVLO circuits are not given enough time to fully discharge the internal nodes, the outputs are not fully disabled.

The effect of the downward line transient can be mitigated by using a larger input capacitor to increase the fall time of the input supply when operating near the minimum V_{IN} .

5.7 Power Dissipation (P_D)

Circuit reliability demands that proper consideration is given to device power dissipation, location of the circuit on the printed circuit board (PCB), and correct sizing of the thermal plane. The PCB area around the regulator must be as free as possible of other heat-generating devices that cause added thermal stresses.

Power dissipation in the regulator depends on the input-to-output voltage difference and load conditions.

$$P_D = (V_{IN} - V_{OUT}) \times I_{OUT} + V_{IN} \times I_{GND}$$

$V_{IN} \times I_{GND}$ represents the static power consumption of the LDO, the value is relatively small and can be ignored. An important note is that power dissipation can be minimized, and thus greater efficiency achieved, by proper selection of the system voltage rails. Proper selection allows the minimum input-to-output voltage differential to be obtained. The low dropout of the device allows for maximum efficiency across a wide range of output voltages.

The main heat conduction path for the device is through the thermal pad on the package. As such, the thermal pad must be soldered to a copper pad area under the device. This pad area contains an array of plated vias that conduct heat to any inner plane areas or to a bottom-side copper plane.

The maximum power dissipation determines the maximum allowable junction temperature (T_J) for the device. Power dissipation and junction temperature are most often related by the junction-to-ambient thermal resistance (θ_{JA}) of the combined PCB, device package, and the temperature of the ambient air (T_A).

$$T_J = T_A + \theta_{JA} \times P_D$$

$$I_{OUT} = (T_J - T_A) / [\theta_{JA} \times (V_{IN} - V_{OUT})]$$

6 Electrical characteristics

6.1 Absolute maximum ratings

The maximum ratings are the limits to which the device can be subjected without permanently damaging the device. Note that the device is not guaranteed to operate properly at the maximum ratings. Exposure to the absolute maximum rating conditions for extended periods may affect device reliability.

Table 6-1 Absolute maximum ratings

Symbol	Parameter	Min	Max	Unit
Voltage	IN, BIAS, PG, EN, OUT	-0.3	7.0	V
	NR/SS, FB	-0.3	3.6	V
Current	OUT	Internally limited		A
	PG(sink current into device)	—	5	mA
Thermal characteristics				
T _J	Operating junction temperature	-55	150	°C
T _{stg}	Storage temperature	-65	150	°C

6.2 Recommended Operating Conditions

Table 6-2 Recommended Operating Conditions

Symbol	Parameter	Min	Typ	Max	Unit
V _{IN}	Input voltage range	1.1	—	6.5	V
V _{BIAS}	Bias supply voltage range	3.0	—	6.5	V
V _{OUT}	Output voltage range	0.8	—	5.5	V
V _{EN}	Enable Voltage range	0	—	V _{IN}	V
I _{OUT}	Output current	0	—	1.2	A
C _{IN}	Input capacitor	—	10	—	uF
C _{OUT}	Output capacitor	—	4.7	—	uF
R _{PG}	Power-good pull-up resistance	10	—	100	kΩ

Symbol	Parameter	Min	Typ	Max	Unit
$C_{NR/SS}$	NR/SS capacitor	—	10	—	nF
C_{FF}	Feed-forward capacitor	—	10	—	nF
R_1	Adjustable resistance in FB network	—	12.1	—	k Ω
R_2	Adjustable resistance in FB network	—	—	160	k Ω
T_J	Operating junction temperature	-40	—	125	$^{\circ}\text{C}$

6.3 Electrical sensitivity

The device is strained in order to determine its performance in terms of electrical sensitivity. Electrostatic discharges (ESD) are applied directly to the pins of the sample.

Table 6-3 Electrostatic Discharge characteristics

Symbol	Parameter	Conditions	Value	Unit
$V_{ESD(HBM)}$	Electrostatic discharge voltage (human body model)	$T_A = 25^{\circ}\text{C}$; JS-001-2017	± 2000	V
$V_{ESD(CDM)}$	Electrostatic discharge voltage (charge device model)	$T_A = 25^{\circ}\text{C}$; JS-002-2018	± 1000	V

6.4 Electrical Specifications

Over operating temperature range ($T_J = -40^{\circ}\text{C}$ to 125°C), Typical values are at $T_J = 25^{\circ}\text{C}$. $V_{IN} = 1.4\text{ V}$ or $V_{IN} = V_{OUT(TARGET)} + 0.4\text{ V}$, $V_{BIAS} = \text{OPEN}$, $V_{OUT(TARGET)} = 0.8\text{ V}$, V_{OUT} connected to $50\ \Omega$ to GND, $V_{EN} = 1.1\text{ V}$, $C_{IN} = 10\ \mu\text{F}$, $C_{OUT} = 47\ \mu\text{F}$, $C_{NR/SS} = 0\text{ nF}$, $C_{FF} = 0\text{ nF}$, and PG pin pulled up to OUT with $100\text{k}\Omega$, unless otherwise noted.

Table 6-4 Electrical characteristics

Symbol	Parameter	Conditions	Min	Typ	Max	Unit
V_{IN}	Input Range	—	1.1	—	6.5	V
V_{BIAS}	BIAS Range	$V_{IN} = 1.1\text{ V}$	3.0	—	6.5	V
V_{FB}	Feedback Voltage	—	—	0.8	—	V
$V_{NR/SS}$	NR/SS pin Voltage	—	—	0.8	—	V
$V_{UVLO1(IN)}$	UVLO1 with BIAS	V_{IN} rising with $V_{BIAS} = 3.0\text{ V}$	—	1.00	1.085	V
$V_{HYS1(IN)}$	UVLO1 hysteresis With	$V_{BIAS} = 3.0\text{ V}$	—	300	—	mV

Symbol	Parameter	Conditions	Min	Typ	Max	Unit
	BIAS					
$V_{UVLO2(IN)}$	UVLO2 without BIAS	V_{IN} rising	—	1.33	1.39	V
$V_{HYS2(IN)}$	UVLO2 hysteresis without BIAS	—	—	230	—	mV
$V_{UVLO(BIAS)}$	UVLO(BIAS)	V_{BIAS} rising, $V_{IN} = 1.1$ V	—	2.72	2.9	V
$V_{HYS(BIAS)}$	UVLO(BIAS) hysteresis With BIAS	$V_{IN} = 1.1$ V	—	250	—	mV
V_{OUT}	Output Voltage Range	Using external resistors	0.8 -1%	—	5.5 +1%	V
	Output Accuracy	$V_{IN} = V_{OUT} + 0.3$ V, 0.8 V $\leq V_{OUT} \leq 5$ V	-1	—	1	%
$\frac{\Delta V_{OUT}}{\Delta V_{IN}}$	Line Regulation	$I_{OUT} = 5$ mA, 1.4 V $\leq V_{IN} \leq 6.5$ V	—	0.07	—	mV/V
$\frac{\Delta V_{OUT}}{\Delta I_{OUT}}$	Load Regulation	5 mA $\leq I_{OUT} \leq 1.2$ A	—	0.08	—	mV/A
V_{DROP}	Dropout Voltage	$V_{IN} = 1.4$ V, $I_{OUT} = 1.2$ A, $V_{FB} = 0.8$ V $- 3\%$	—	60	120	mV
		$V_{IN} = 5.4$ V, $I_{OUT} = 1.2$ A, $V_{FB} = 0.8$ V $- 3\%$	—	70	150	mV
		$V_{IN} = 1.1$ V, $V_{BIAS} = 5$ V, $I_{OUT} = 1.2$ A, $V_{FB} = 0.8$ V $- 3\%$	—	50	100	mV
I_{LIM}	Output Current Limit	$V_{OUT} = 90\% * V_{OUT(TARGET)}$ $V_{IN} = V_{OUT(TARGET)} + 400$ mV	1.8	2.1	2.4	A
I_{SC}	Short-Circuit Current Limit	$R_{LOAD} = 20$ m Ω	—	1.2	—	A
I_{GND}	Ground Pin Current	$V_{IN} = 6.5$ V, $I_{OUT} = 5$ mA	—	3.0	4.2	mA
		$V_{IN} = 1.4$ V, $I_{OUT} = 1.2$ A	—	4.2	5.5	mA
		Shutdown, PG = OPEN, $V_{IN} = 6.5$ V, $V_{EN} = 0.5$ V	—	—	25	μ A
I_{BIAS}	BIAS Pin Current	$V_{IN} = 1.1$ V, $V_{BIAS} = 6.5$ V, $V_{OUT} = 0.8$ V, $I_{OUT} = 1.2$ A	—	3.0	4.2	mA
I_{EN}	EN Pin Current	$V_{IN} = 6.5$ V, $V_{EN} = 0$ V and 6.5 V	-0.1	—	0.1	μ A
V_{EN_H}	EN Pin High-Level	—	1.1	—	6.5	V
V_{EN_L}	EN Pin Low-Level	—	0	—	0.5	V
$V_{IT(PG)}$	PG Pin Threshold	For falling V_{OUT}	82% * V_{OUT}	89% * V_{OUT}	93% * V_{OUT}	V

Symbol	Parameter	Conditions	Min	Typ	Max	Unit	
V_{HYS_PG}	PG Pin Hysteresis	For rising V_{OUT}	—	2% * V_{OUT}	—	V	
V_{PG_L}	PG Pin Low-Level output Voltage	$V_{OUT} < V_{IT(PG)}$, $I_{PG} = -1 \text{ mA}$	—	—	0.1	V	
I_{PG_LK}	PG Pin Low-leakage Current	$V_{OUT} > V_{IT(PG)}$, $V_{PG} = 6.5 \text{ V}$	—	—	1	μA	
$I_{NR/SS}$	NR/SS Pin Charging Current	$V_{IN} = \text{GND}$, $V_{IN} = 6.5 \text{ V}$	4	7.2	9	μA	
I_{FB}	FB Pin leakage Current	$V_{IN} = 6.5 \text{ V}$	-100	—	100	nA	
PSRR	Power Supply Ripple Rejection	$V_{IN}-V_{OUT} = 0.4 \text{ V}$ $I_{OUT} = 1.2 \text{ A}$ $C_{NR/SS} = 100 \text{ nF}$ $C_{FF} = 10 \text{ nF}$ $C_{OUT} = 47\mu\text{F}/10\mu\text{F}/10\mu\text{F}$	$f = 10 \text{ KHz}$, $V_{OUT} = 0.8 \text{ V}$ $V_{BIAS} = 5 \text{ V}$	—	42	—	dB
			$f = 500\text{KHz}$, $V_{OUT} = 0.8 \text{ V}$ $V_{BIAS} = 5\text{V}$	—	39	—	dB
			$f = 10 \text{ KHz}$, $V_{OUT} = 5 \text{ V}$	—	40	—	dB
			$f = 500 \text{ KHz}$, $V_{OUT} = 5 \text{ V}$	—	25	—	dB
V_N	Output Noise Voltage	$BW = 10 \text{ Hz to } 100 \text{ KHz}$, $V_{in} = 1.1 \text{ V}$ $V_{OUT} = 0.8 \text{ V}$, $V_{BIAS} = 5 \text{ V}$, $I_{OUT} = 1.2 \text{ A}$, $C_{NR/SS} = 100 \text{ nF}$, $C_{FF} = 10 \text{ nF}$ $C_{OUT} = 47 \text{ uF}/10 \text{ uF}/10 \text{ uF}$	—	4.4	—	μV_{RMS}	
		$BW = 10 \text{ Hz to } 100 \text{ KHz}$, $V_{OUT} = 5.0 \text{ V}$, $I_{OUT} = 1.2 \text{ A}$, $C_{NR/SS} = 100 \text{ nF}$, $C_{FF} = 10 \text{ nF}$ $C_{OUT} = 47 \text{ uF}/10 \text{ uF}/10 \text{ uF}$	—	7.7	—	μV_{RMS}	
T_{SD}	Thermal Shutdown Threshold	Shut down, temperature increasing	—	160	—	$^{\circ}\text{C}$	
		Reset, temperature increasing	—	140	—	$^{\circ}\text{C}$	

6.5 Typical Characteristics

at TA = 25°C, V_{IN} = 1.4 V or V_{IN} = V_{OUT(NOM)} + 0.4 V (whichever is greater), V_{BIAS} = OPEN, V_{OUT(NOM)} = 0.8 V, V_{EN} = 1.1 V, C_{OUT} = 47 μF || 10 μF, C_{NR/SS} = 10 nF, C_{FF} = 0 nF, and PG pin pulled up to V_{IN} with 100 kΩ (unless otherwise noted)

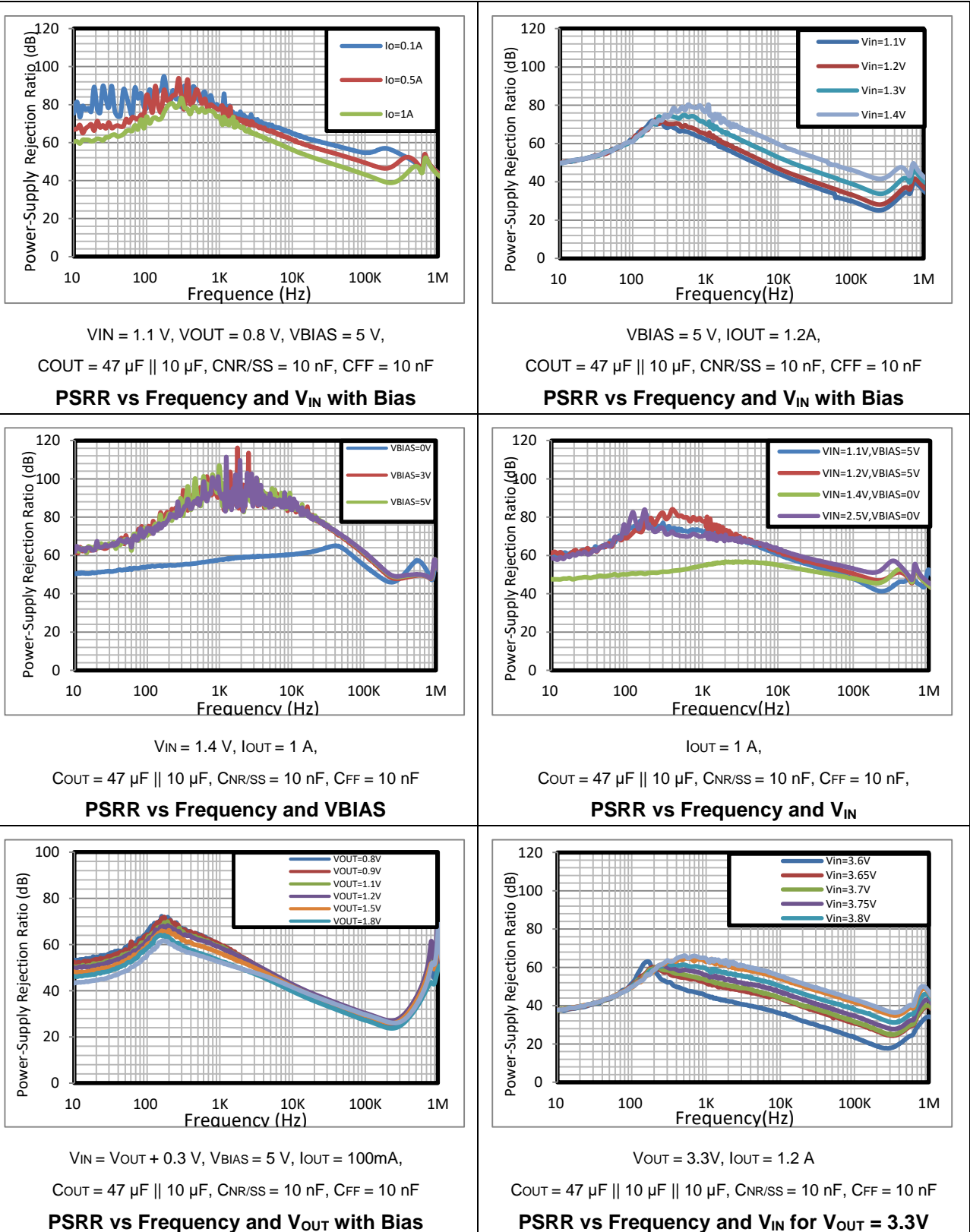

Typical Characteristics

at TA = 25°C, V_{IN} = 1.4 V or V_{IN} = V_{OUT(NOM)} + 0.4 V (whichever is greater), V_{BIAS} = OPEN, V_{OUT(NOM)} = 0.8 V, V_{EN} = 1.1 V, C_{OUT} = 47 μF || 10 μF, C_{NR/SS} = 10 nF, C_{FF} = 0 nF, and PG pin pulled up to V_{IN} with 100 kΩ (unless otherwise noted)

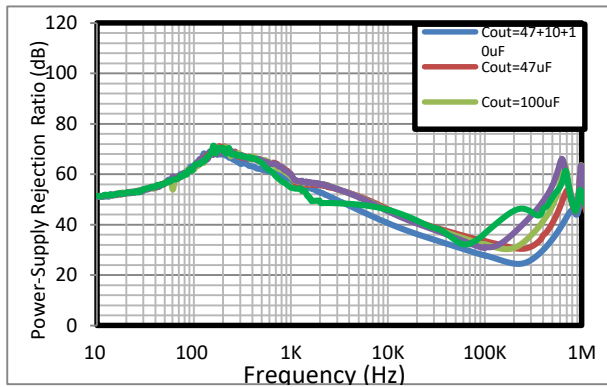

V_{IN} = 1.3 V, V_{BIAS} = 5 V, V_{OUT} = 1.0V, I_{OUT} = 1.2 A
C_{NR/SS} = 10 nF, C_{FF} = 10 nF

PSRR vs Frequency and C_{OUT}

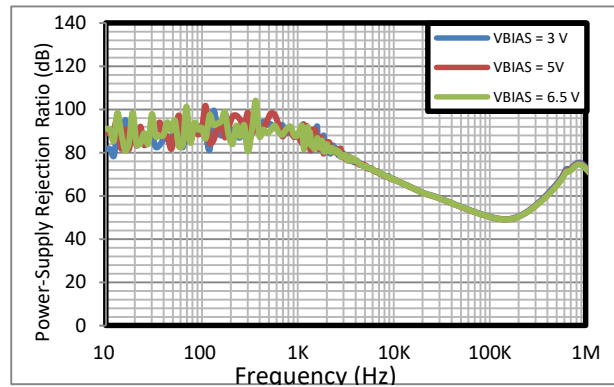

V_{IN} = 1.3 V, V_{OUT} = 1.0V, I_{OUT} = 1.2 A
C_{OUT} = 47 μF || 10 μF, C_{NR/SS} = 10 nF, C_{FF} = 10 nF

PSRR vs Frequency and BIAS

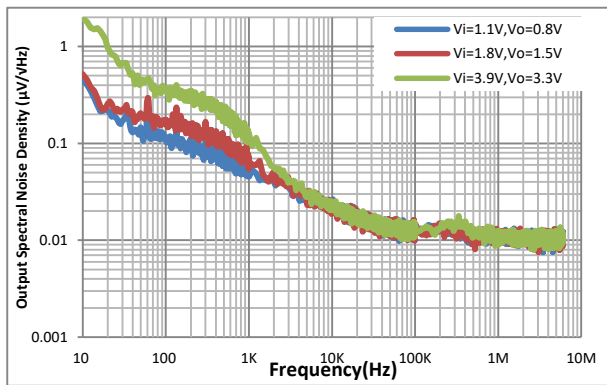

V_{IN} = V_{OUT} + 0.3 V and V_{BIAS} = 5 V for V_{OUT} ≤ 2.2 V, I_{OUT} = 1.2 A,
C_{OUT} = 47 μF || 10 μF, C_{NR/SS} = 10 nF, C_{FF} = 10 nF,

Output Noise vs Frequency and Output Voltage

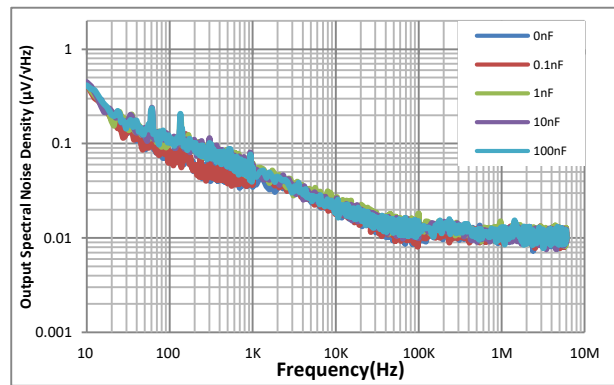

V_{IN} = 1.1V, V_{BIAS} = 5 V, V_{OUT} = 0.8 V, I_{OUT} = 1.2 A,
C_{OUT} = 47 μF || 10 μF, C_{NR/SS} = 10 nF,

Output Noise vs Frequency and C_{FF}

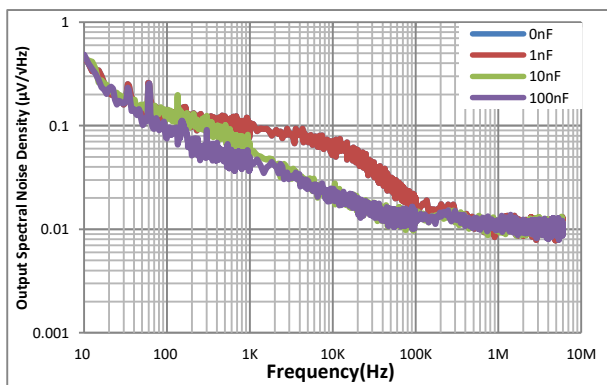

V_{IN} = 1.1V, V_{BIAS} = 5 V, V_{OUT} = 0.8 V, I_{OUT} = 1.2 A,
C_{OUT} = 47 μF || 10 μF, C_{FF} = 10 nF,

Output Noise vs Frequency and C_{NR/SS}

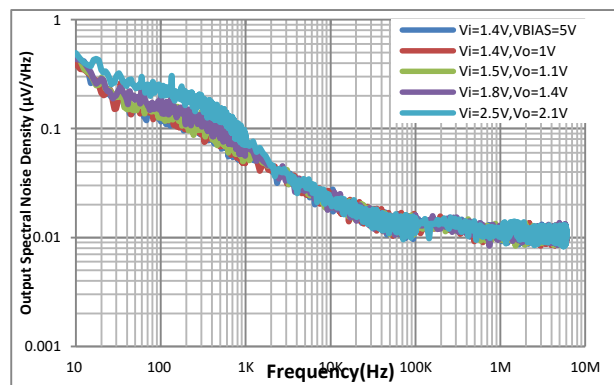

I_{OUT} = 1.2 A,
C_{OUT} = 47 μF || 10 μF, C_{NR/SS} = 10 nF, C_{FF} = 10 nF,

Output Noise vs Frequency and Input Voltage

Typical Characteristics

at TA = 25°C, V_{IN} = 1.4 V or V_{IN} = V_{OUT(NOM)} + 0.4 V (whichever is greater), V_{BIAS} = OPEN, V_{OUT(NOM)} = 0.8 V, V_{EN} = 1.1 V, C_{OUT} = 47 μF || 10 μF, C_{NR/SS} = 10 nF, C_{FF} = 0 nF, and PG pin pulled up to V_{IN} with 100 kΩ (unless otherwise noted)

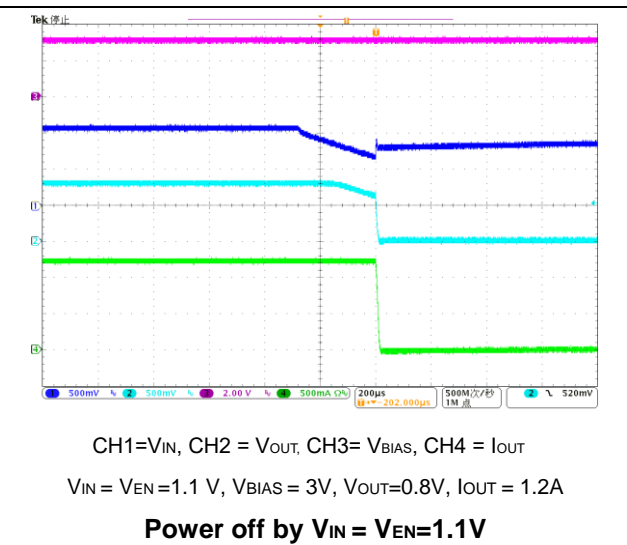
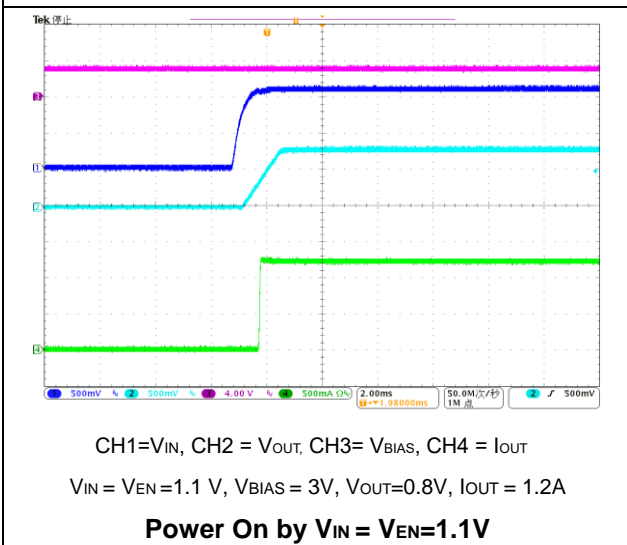
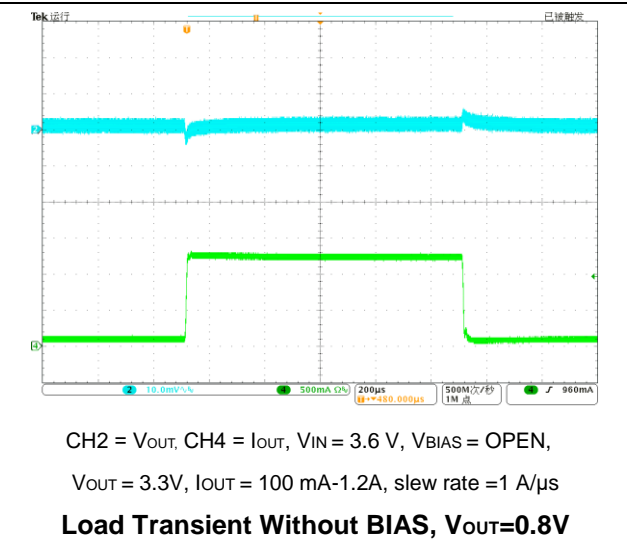
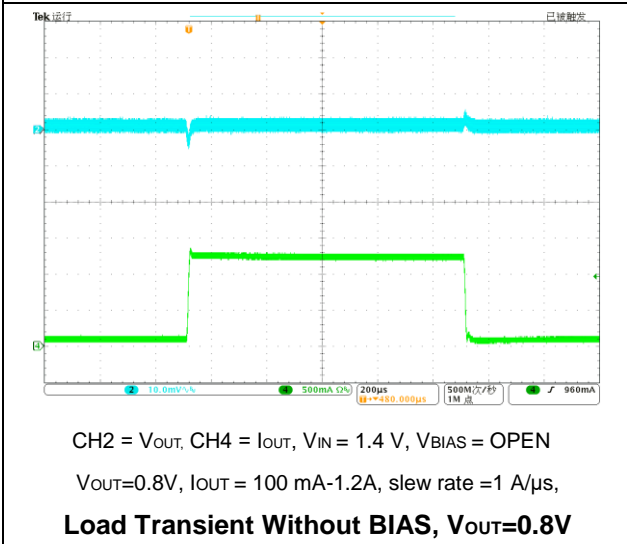
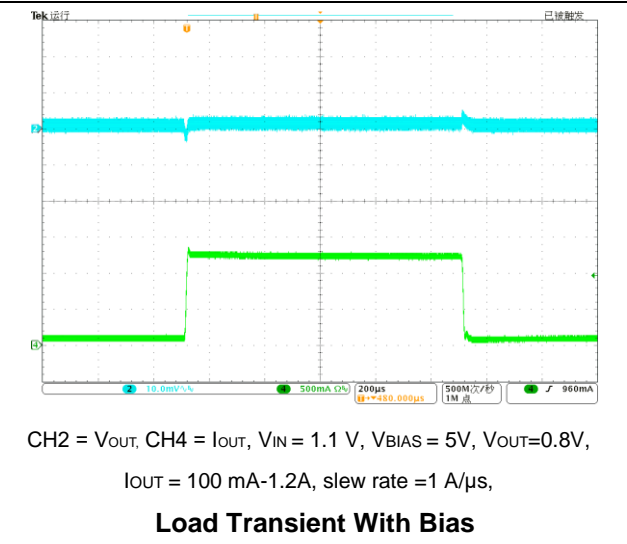
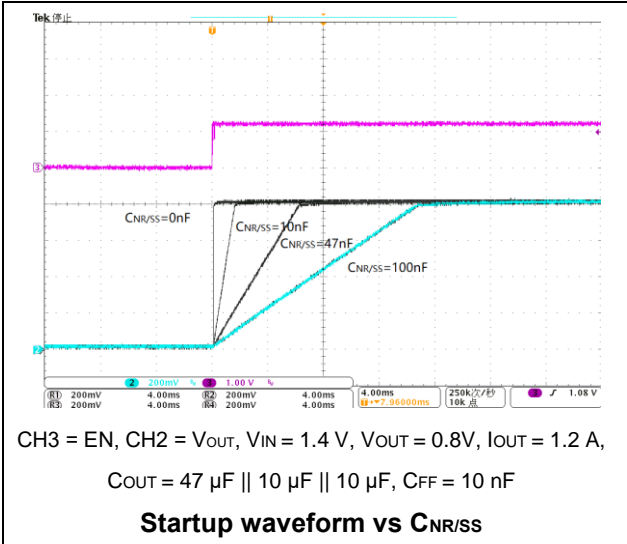

Typical Characteristics

at $T_A = 25^\circ\text{C}$, $V_{IN} = 1.4\text{ V}$ or $V_{IN} = V_{OUT(NOM)} + 0.4\text{ V}$ (whichever is greater), $V_{BIAS} = \text{OPEN}$, $V_{OUT(NOM)} = 0.8\text{ V}$, $V_{EN} = 1.1\text{ V}$, $C_{OUT} = 47\ \mu\text{F} \parallel 10\ \mu\text{F}$, $C_{NR/SS} = 10\ \text{nF}$, $C_{FF} = 0\ \text{nF}$, and PG pin pulled up to V_{IN} with $100\ \text{k}\Omega$ (unless otherwise noted)

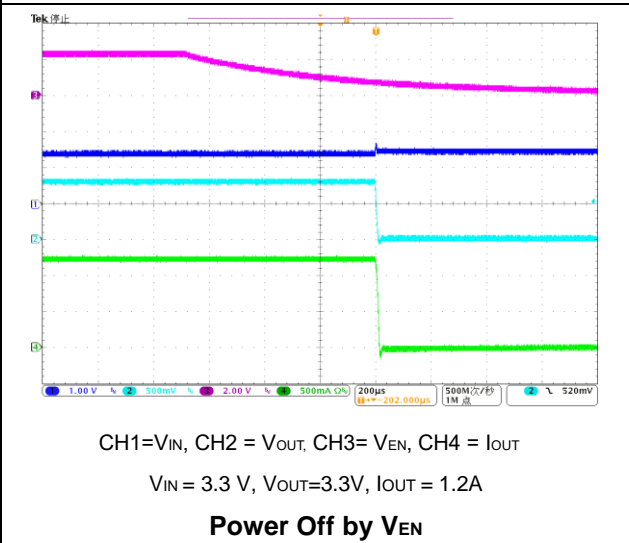
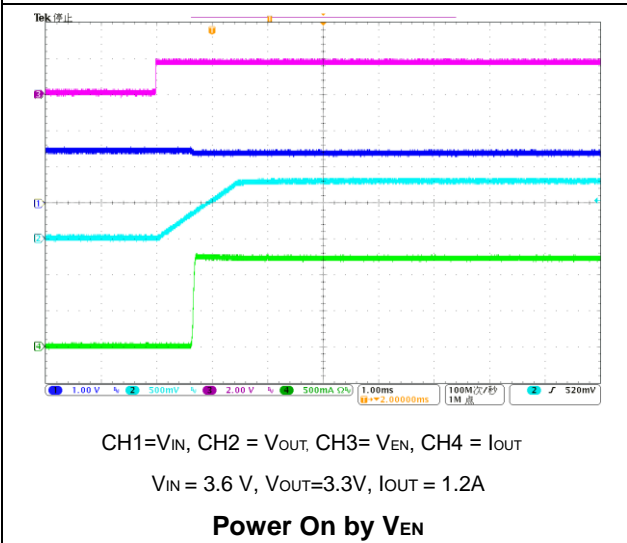
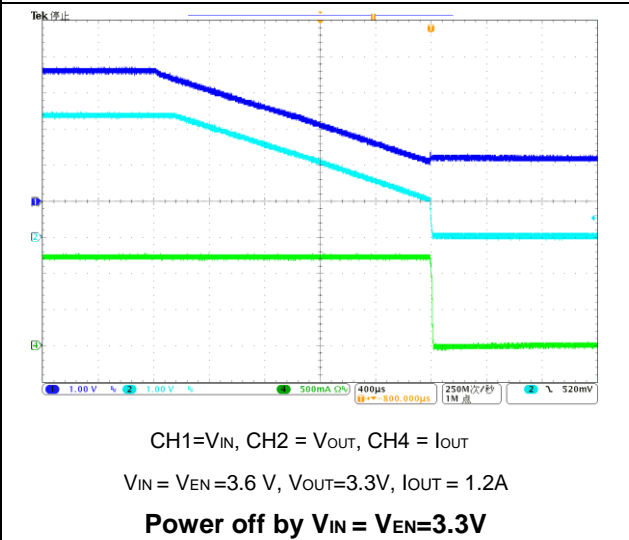
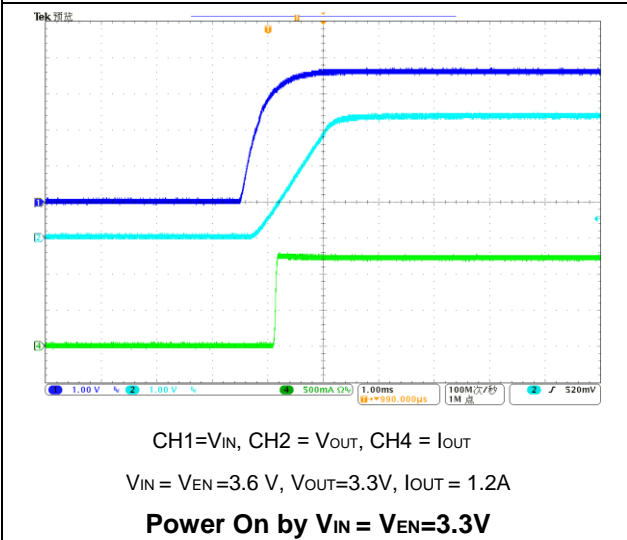
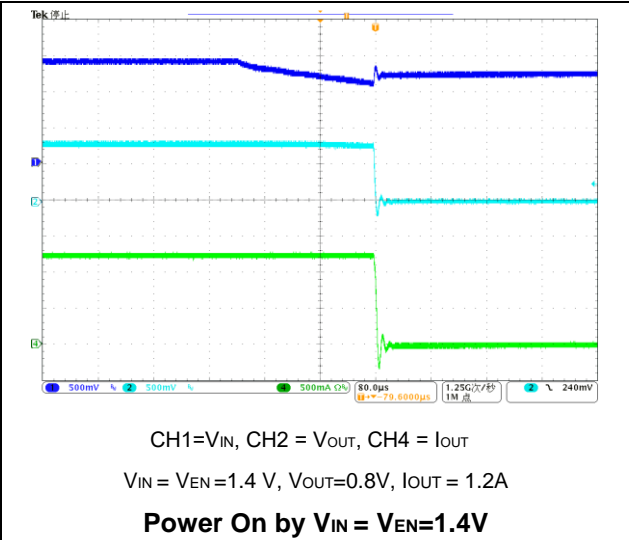
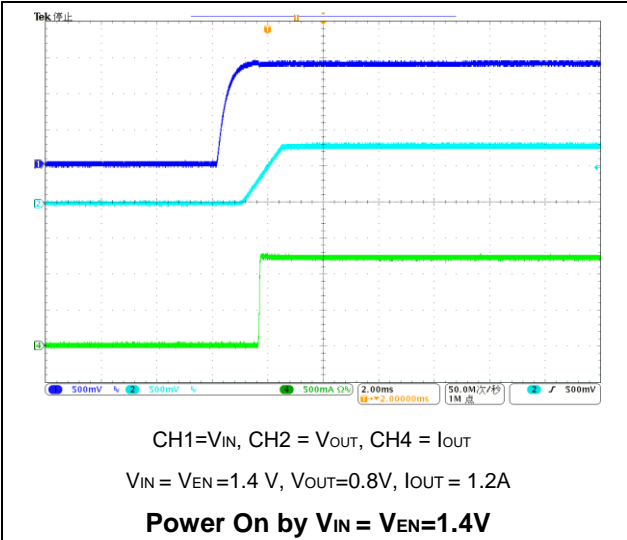

Typical Characteristics

at TA = 25°C, $V_{IN} = 1.4\text{ V}$ or $V_{IN} = V_{OUT(NOM)} + 0.4\text{ V}$ (whichever is greater), $V_{BIAS} = \text{OPEN}$, $V_{OUT(NOM)} = 0.8\text{ V}$, $V_{EN} = 1.1\text{ V}$, $C_{OUT} = 47\text{ }\mu\text{F} \parallel 10\text{ }\mu\text{F}$, $C_{NR/SS} = 10\text{ nF}$, $C_{FF} = 0\text{ nF}$, and PG pin pulled up to V_{IN} with $100\text{ k}\Omega$ (unless otherwise noted)

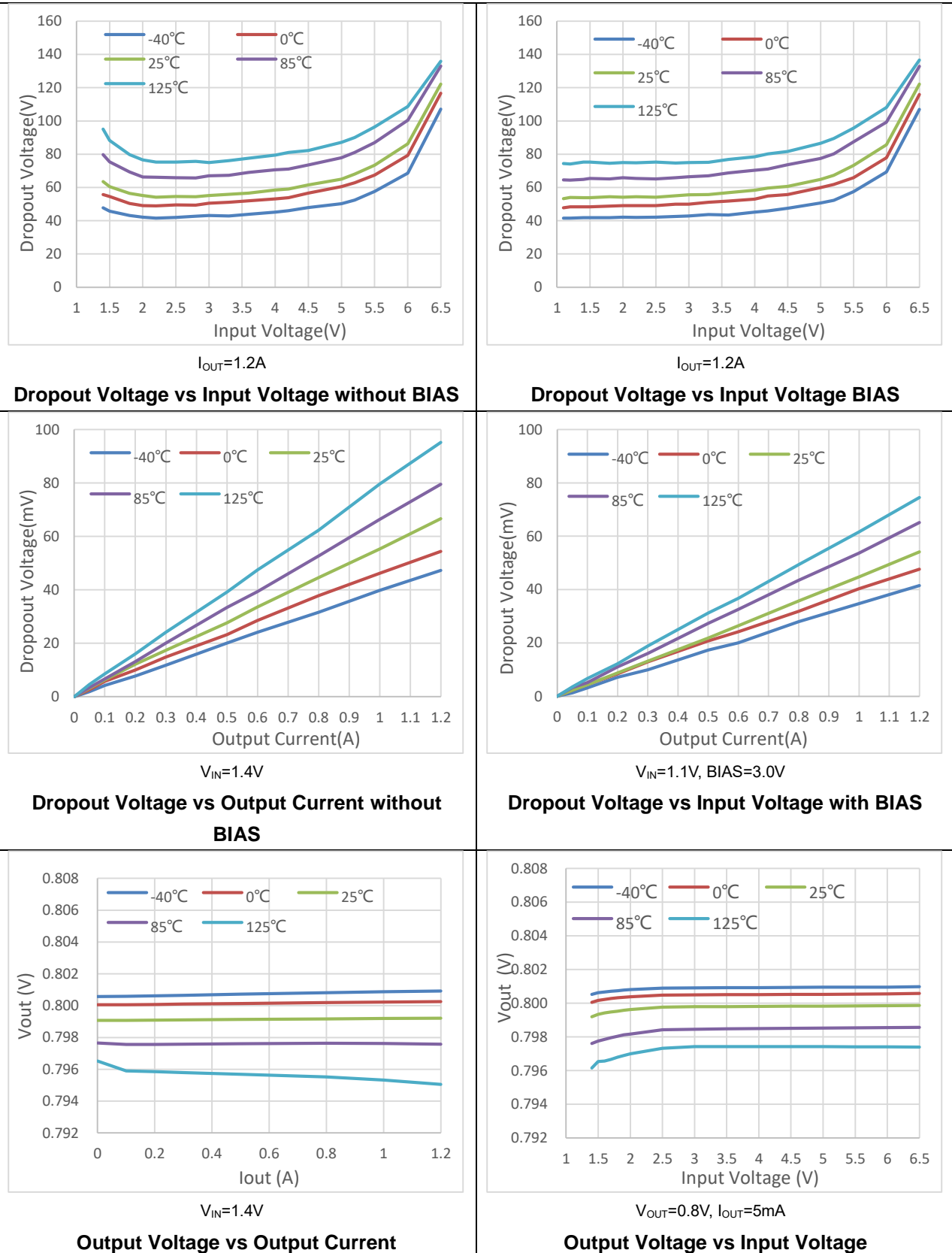

Typical Characteristics

at TA = 25°C, V_{IN} = 1.4 V or V_{IN} = V_{OUT(NOM)} + 0.4 V (whichever is greater), V_{BIAS} = OPEN, V_{OUT(NOM)} = 0.8 V, V_{EN} = 1.1 V, C_{OUT} = 47 μF || 10 μF, C_{NR/SS} = 10 nF, C_{FF} = 0 nF, and PG pin pulled up to V_{IN} with 100 kΩ (unless otherwise noted)

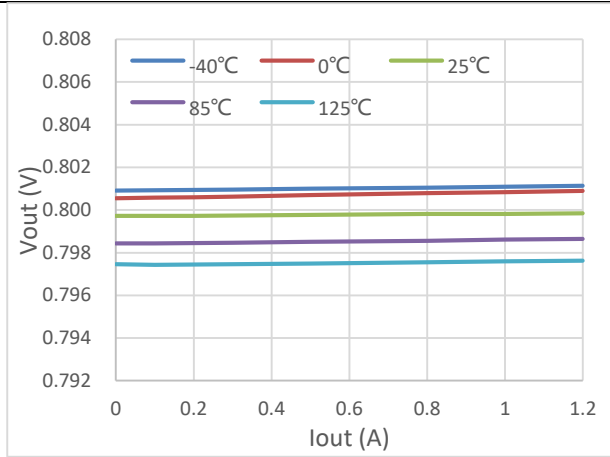

V_{IN}=1.1V, V_{BIAS}=3.0V

Output Voltage vs Output Current

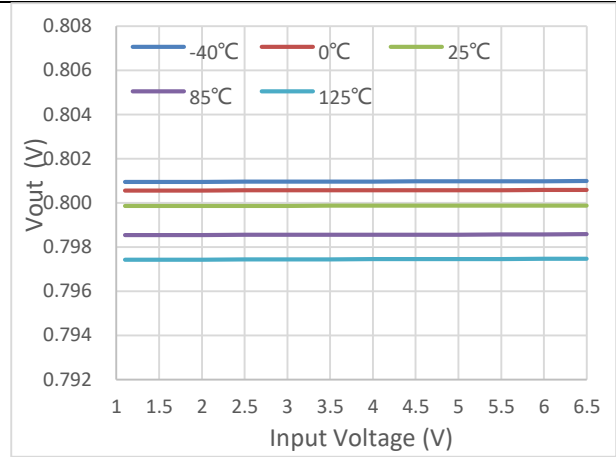

V_{BIAS}=6.5V V_{OUT}=0.8V, I_{OUT}=5mA

Output Voltage vs Input Voltage

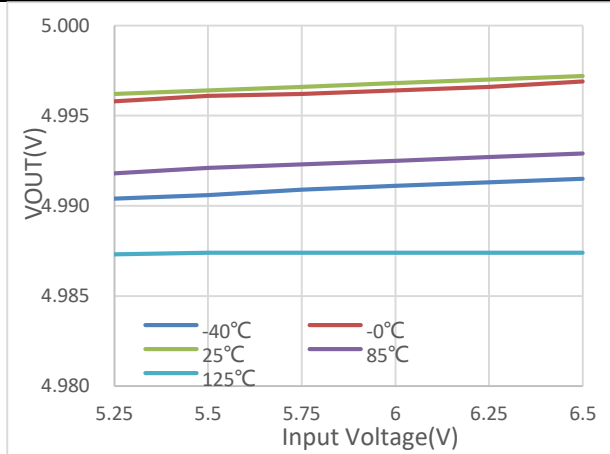

V_{OUT}=5V, I_{OUT}=5mA

Output Voltage vs Input Voltage

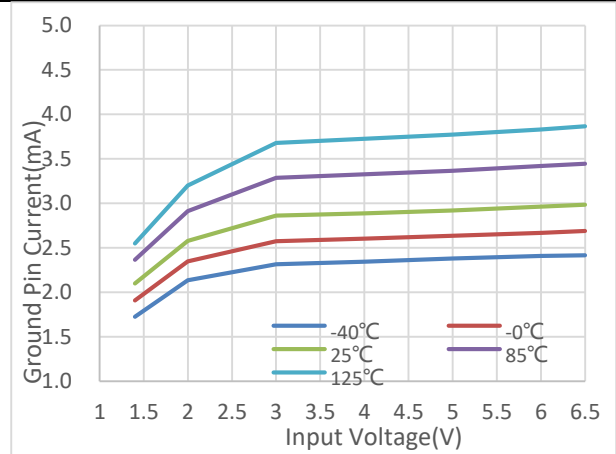

V_{BIAS}=0V, I_{OUT}=5mA

Ground Pin Current vs Input Voltage

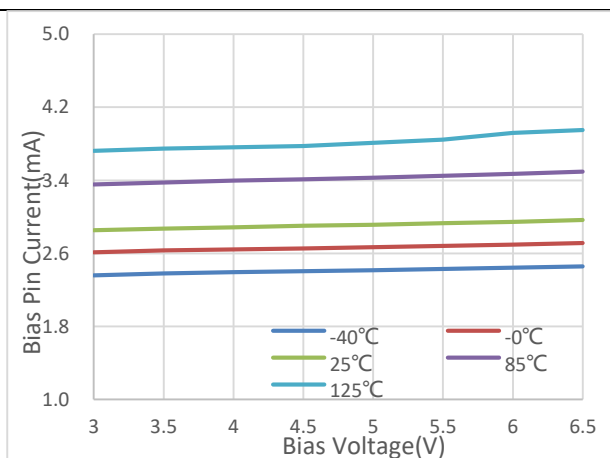

V_{IN}=1.1V, I_{OUT}=5mA

BIAS Pin Current vs BIAS Voltage

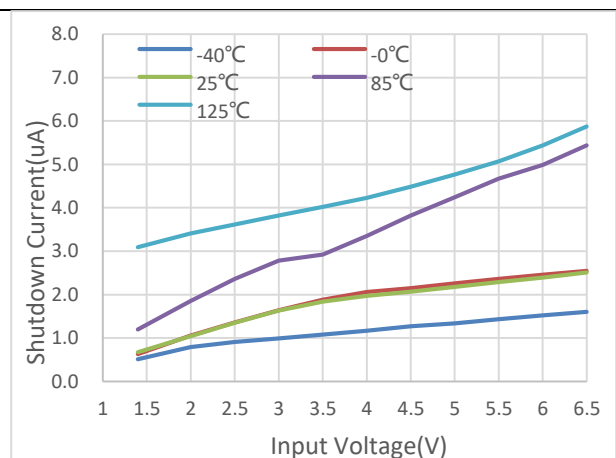

V_{BIAS}=0V

Shutdown Current vs Input Voltage

Typical Characteristics

at TA = 25°C, V_{IN} = 1.4 V or V_{IN} = V_{OUT(NOM)} + 0.4 V (whichever is greater), V_{BIAS} = OPEN, V_{OUT(NOM)} = 0.8 V, V_{EN} = 1.1 V, C_{OUT} = 47 μF || 10 μF, C_{NR/SS} = 10 nF, C_{FF} = 0 nF, and PG pin pulled up to V_{IN} with 100 kΩ (unless otherwise noted)

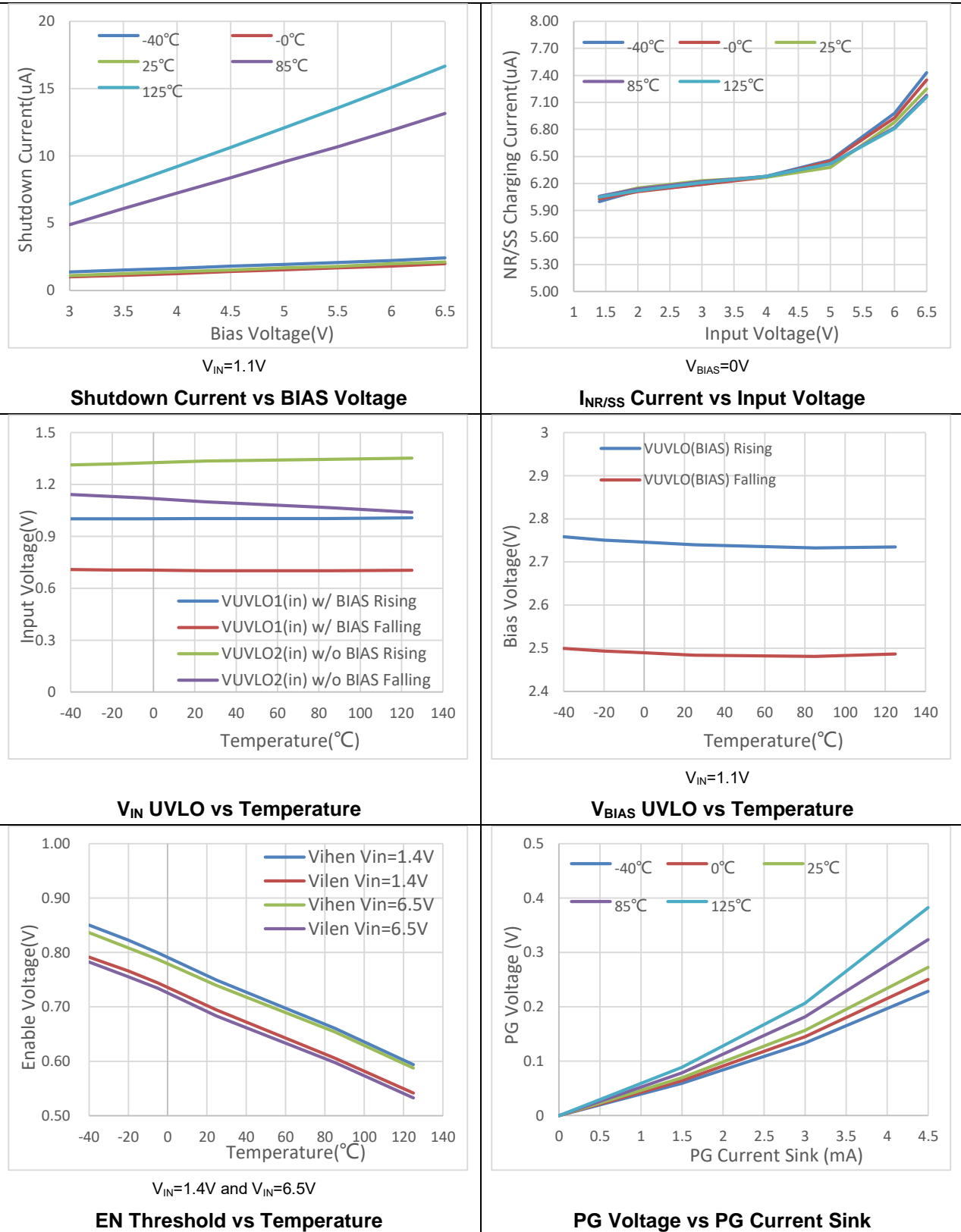

Typical Characteristics

at $T_A = 25^\circ\text{C}$, $V_{IN} = 1.4\text{ V}$ or $V_{IN} = V_{OUT(NOM)} + 0.4\text{ V}$ (whichever is greater), $V_{BIAS} = \text{OPEN}$, $V_{OUT(NOM)} = 0.8\text{ V}$, $V_{EN} = 1.1\text{ V}$, $C_{OUT} = 47\ \mu\text{F} \parallel 10\ \mu\text{F}$, $C_{NR/SS} = 10\ \text{nF}$, $C_{FF} = 0\ \text{nF}$, and PG pin pulled up to V_{IN} with $100\ \text{k}\Omega$ (unless otherwise noted)

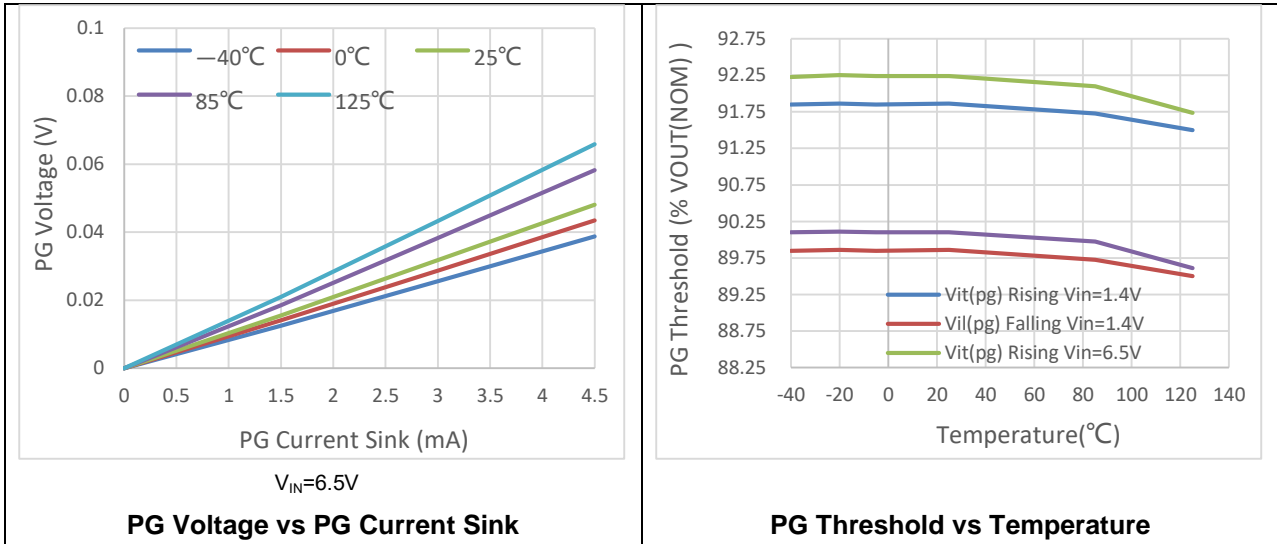

7 Typical application circuit

Figure 7-1 Typical GD30LD3137x application circuit with adjustable resistance

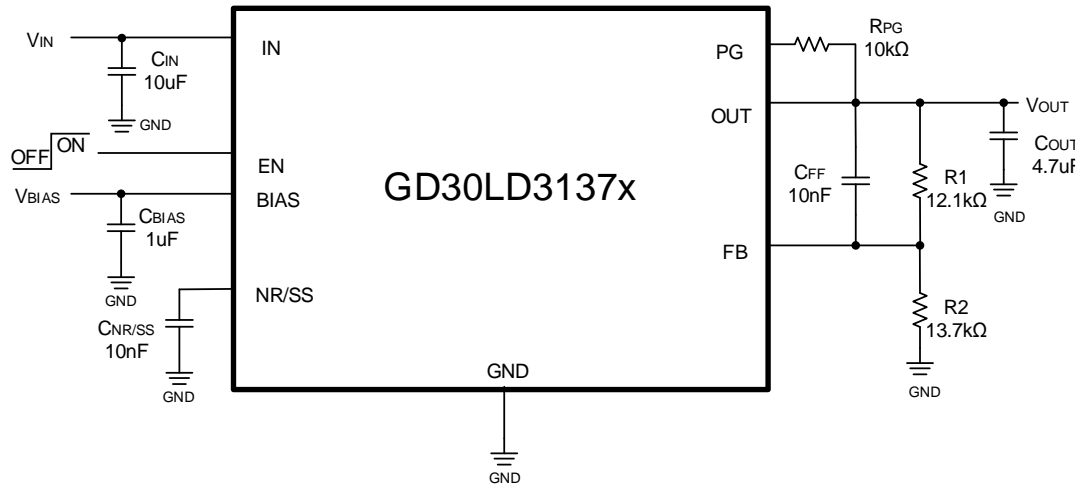
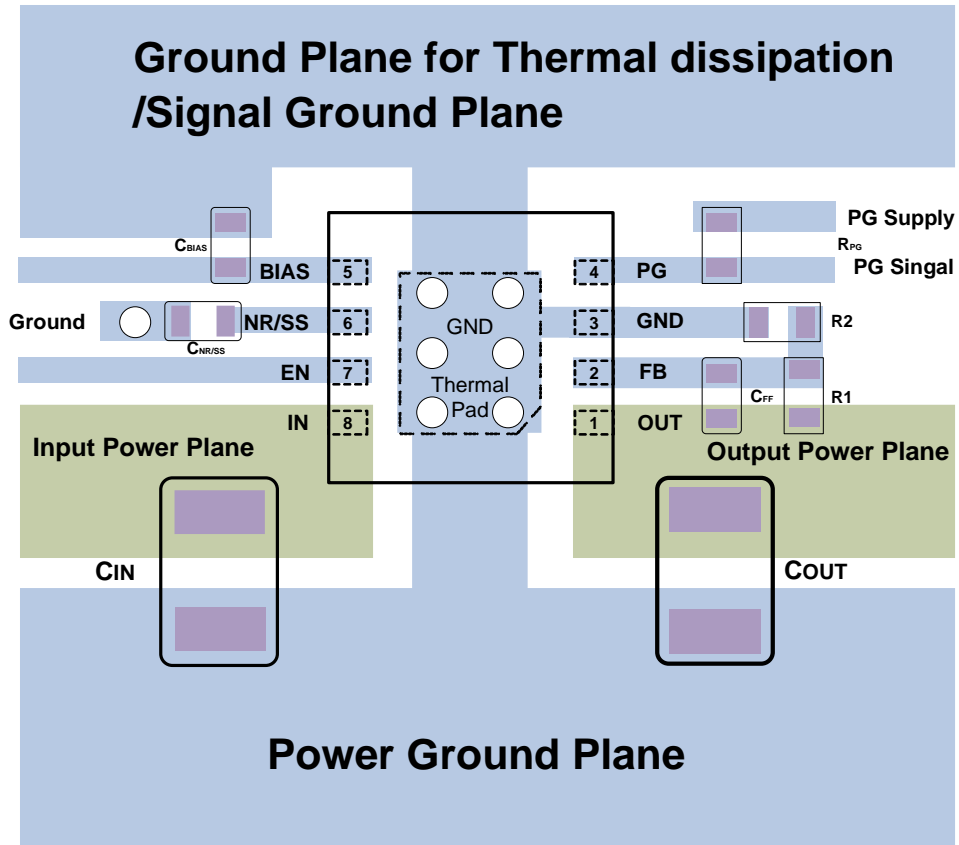

Table 7-1 Adjusted V_{OUT} by external feedback resistor

$V_{OUT}(V)$	External Feedback Resistor	
	R1 (kΩ)	R2(kΩ)
0.80	0	NC
0.90	12.1	97.6
1.00	12.1	48.7
1.10	12.1	32.4
1.20	12.1	24.3
1.50	12.1	13.7
1.80	12.1	9.76
1.90	12.1	8.87
2.50	12.1	5.76
2.85	12.1	4.75
3.00	12.1	4.42
3.30	12.1	3.83
3.60	12.1	3.48
4.50	12.1	2.61
5.00	12.1	2.32
5.20	12.1	2.2
5.50	12.1	2.06

8 Layout guideline

Figure 8-1 Typical GD30LD3137x layout guideline



Notes:

1. The capacitor C_{IN} and C_{OUT} should be placed on the top layer to reduce parasitic parameters.
2. All capacitors are as close as possible to the corresponding pins of the LDO.

9 Package information

9.1 DFN8 package outline dimensions

Figure 9-1 DFN8 package outline

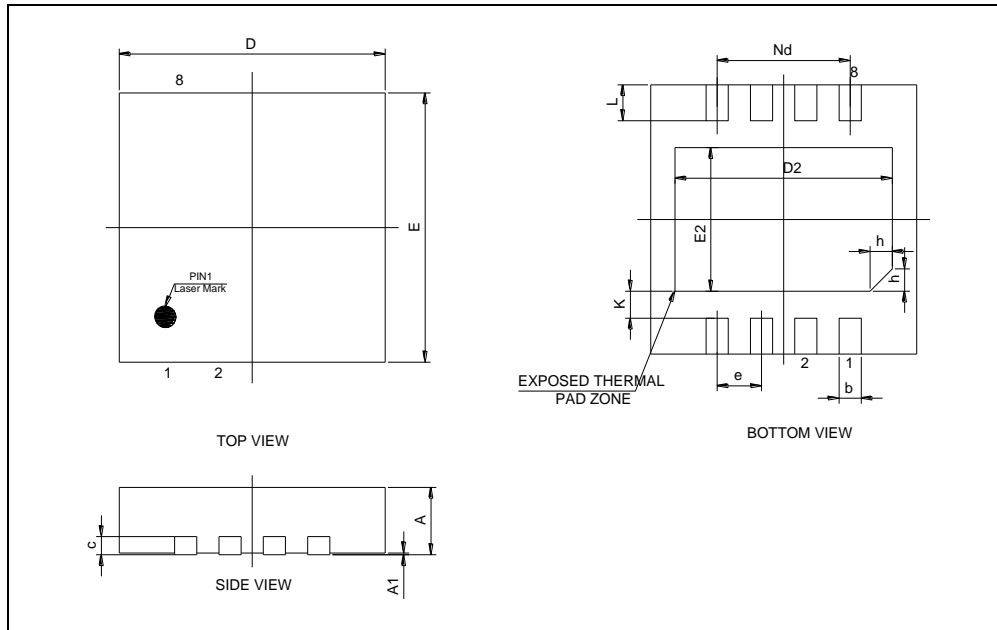
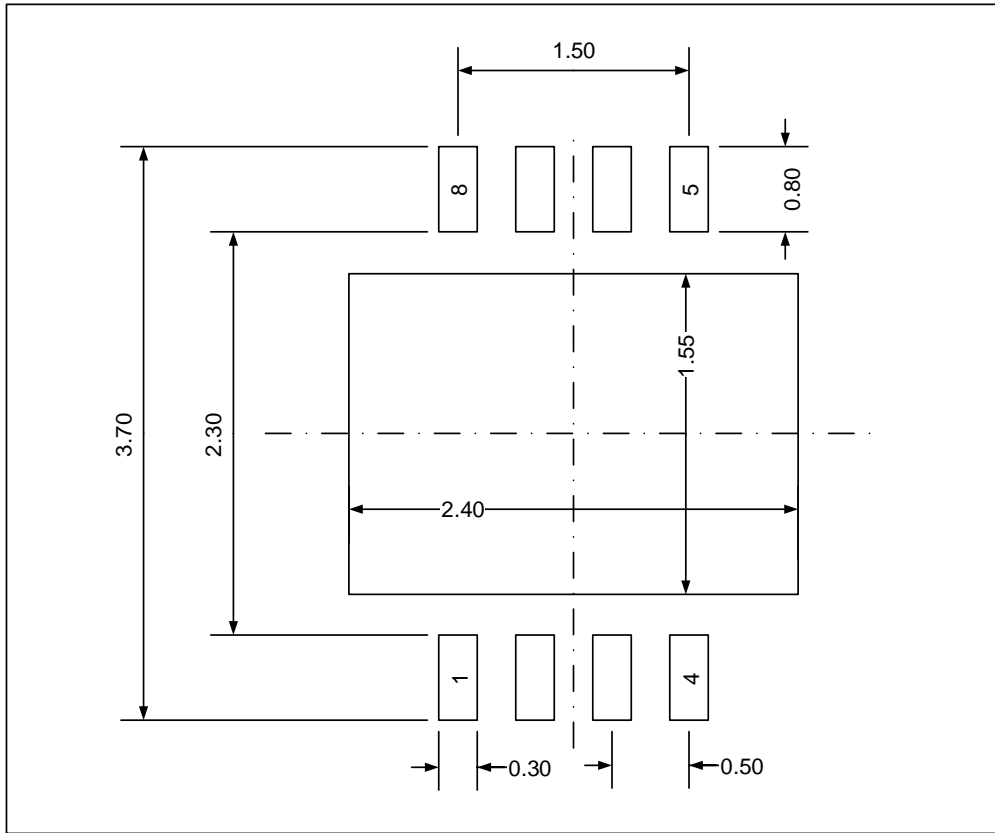

Table 9-1. DFN8 dimensions

Symbol	Min	Nom	Max
A	0.70	0.75	0.80
A1	0	0.02	0.05
b	0.20	0.25	0.30
c	0.203REF		
D	2.90	3.00	3.10
D2	2.35	2.45	2.55
E	2.90	3.00	3.10
E2	1.50	1.60	1.70
e	0.50BSC		
h	0.20	0.25	0.30
K	0.30REF		
L	0.35	0.40	0.45
Nd	1.50BSC		

(Original dimensions are in millimeters)

Figure 9-2 DFN8 recommended footprint



(Original dimensions are in millimeters)

9.2 Thermal characteristics

Thermal resistance is used to characterize the thermal performance of the package device, which is represented by the Greek letter “ Θ ”. For semiconductor devices, thermal resistance represents the steady-state temperature rise of the chip junction due to the heat dissipated on the chip surface.

Θ_{JA} : Thermal resistance, junction-to-ambient.

Θ_{JB} : Thermal resistance, junction-to-board.

Θ_{JC} : Thermal resistance, junction-to-case.

Ψ_{JB} : Thermal characterization parameter, junction-to-board.

Ψ_{JT} : Thermal characterization parameter, junction-to-top center.

$$\Theta_{JA} = (T_J - T_A)/P_D$$

$$\Theta_{JB} = (T_J - T_B)/P_D$$

$$\Theta_{JC} = (T_J - T_C)/P_D$$

Where, T_J = Junction temperature.

T_A = Ambient temperature

T_B = Board temperature

T_C = Case temperature which is monitoring on package surface

P_D = Total power dissipation

Θ_{JA} represents the resistance of the heat flows from the heating junction to ambient air. It is an indicator of package heat dissipation capability. Lower Θ_{JA} can be considerate as better overall thermal performance. Θ_{JA} is generally used to estimate junction temperature.

Θ_{JB} is used to measure the heat flow resistance between the chip surface and the PCB board.

Θ_{JC} represents the thermal resistance between the chip surface and the package top case.

Θ_{JC} is mainly used to estimate the heat dissipation of the system (using heat sink or other heat dissipation methods outside the device package).

Table 9-2. Package thermal characteristics⁽¹⁾

Symbol	Condition	Package	Value	Unit
Θ_{JA}	Natural convection, 2S2P PCB	DFN8	74.9	°C/W
Θ_{JB}	Cold plate, 2S2P PCB	DFN8	31.8	°C/W
Θ_{JC}	Cold plate, 2S2P PCB	DFN8	36.7	°C/W
Ψ_{JB}	Natural convection, 2S2P PCB	DFN8	31.8	°C/W
Ψ_{JT}	Natural convection, 2S2P PCB	DFN8	2.60	°C/W

(1) Thermal characteristics are based on simulation, and meet JEDEC specification.

10 Ordering information

Table 10-1 Part ordering code for GD30LD3137x devices

Ordering Code	Package	Package Type	Packing Type	MOQ	Temperature Junction Range
GD30LD3137WETR	DFN8(3X3)	Green	Tape&Reel	3000	-40°C to +125°C

11 Revision history

Table 11-1 Revision history

Revision No.	Description	Date
1.0	Initial Release	2023

Important Notice

This document is the property of GigaDevice Semiconductor Inc. and its subsidiaries (the "Company"). This document, including any product of the Company described in this document (the "Product"), is owned by the Company according to the laws of the People's Republic of China and other applicable laws. The Company reserves all rights under such laws and no Intellectual Property Rights are transferred (either wholly or partially) or licensed by the Company (either expressly or impliedly) herein. The names and brands of third party referred thereto (if any) are the property of their respective owner and referred to for identification purposes only.

The Company makes no representations or warranties of any kind, express or implied, with regard to the merchantability and the fitness for a particular purpose of the Product, nor does the Company assume any liability arising out of the application or use of any Product described in this document. Any information provided in this document is provided only for reference purposes. It is the sole responsibility of the user of this document to determine whether the Product is suitable and fit for its applications and products planned, and properly design, program, and test the functionality and safety of its applications and products planned using the Product. Unless otherwise expressly specified in the datasheet of the Product, the Product is designed, developed, and/or manufactured for ordinary business, industrial, personal, and/or household applications only, and the Product is not designed or intended for use in (i) safety critical applications such as weapons systems, nuclear facilities, atomic energy controller, combustion controller, aeronautic or aerospace applications, traffic signal instruments, pollution control or hazardous substance management; (ii) life-support systems, other medical equipment or systems (including life support equipment and surgical implants); (iii) automotive applications or environments, including but not limited to applications for active and passive safety of automobiles (regardless of front market or aftermarket), for example, EPS, braking, ADAS (camera/fusion), EMS, TCU, BMS, BSG, TPMS, Airbag, Suspension, DMS, ICMS, Domain, ESC, DCDC, e-clutch, advanced-lighting, etc.. Automobile herein means a vehicle propelled by a self-contained motor, engine or the like, such as, without limitation, cars, trucks, motorcycles, electric cars, and other transportation devices; and/or (iv) other uses where the failure of the device or the Product can reasonably be expected to result in personal injury, death, or severe property or environmental damage (collectively "Unintended Uses"). Customers shall take any and all actions to ensure the Product meets the applicable laws and regulations. The Company is not liable for, in whole or in part, and customers shall hereby release the Company as well as its suppliers and/or distributors from, any claim, damage, or other liability arising from or related to all Unintended Uses of the Product. Customers shall indemnify and hold the Company, and its officers, employees, subsidiaries, affiliates as well as its suppliers and/or distributors harmless from and against all claims, costs, damages, and other liabilities, including claims for personal injury or death, arising from or related to any Unintended Uses of the Product.

Information in this document is provided solely in connection with the Product. The Company reserves the right to make changes, corrections, modifications or improvements to this document and the Product described herein at any time without notice. The Company shall have no responsibility whatsoever for conflicts or incompatibilities arising from future changes to them. Information in this document supersedes and replaces information previously supplied in any prior versions of this document.